

# reversible pump - series XV

STANDARD GERMAN "BH" TYPE PUMP  
 ø32 BODY-SHAPED FLANGE - MILLED SHANK

**XV-1R**

**X 1 R 25 19 C B B E**

Series	X	series XV
Group	1	group 1
Category	R	reversible pump
Displacement	25	3.8
Flange	19	Ø32 BH reversible rotation
Shaft	C	CF001 - Milled shank ø10 - thk.5 ("BH" Standard German)
Body	IN	inlet - 3/8" GAS
	OUT	outlet - 3/8" GAS
Cover	E	with drainage 1/4" BSP

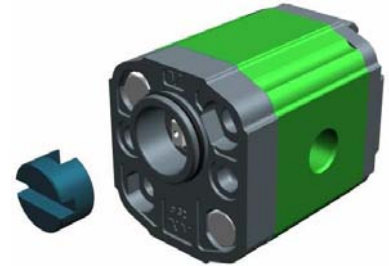

**XR161**

Technical data table

TYPE	Displacement cm3/rev	Max. Pressure		CODE	
		P1 bar	P3 bar	External drainage	Internal drainage
XV-1R/0.9	0,91	240	280	X 1 R 16 19 C B B E	X 1 R 16 19 C B B F
XV-1R/1.2	1,17	250	290	X 1 R 17 19 C B B E	X 1 R 17 19 C B B F
XV-1R/1.7	1,56	250	290	X 1 R 18 19 C B B E	X 1 R 18 19 C B B F
XV-1R/2.2	2,08	250	290	X 1 R 20 19 C B B E	X 1 R 20 19 C B B F
XV-1R/2.6	2,60	250	300	X 1 R 21 19 C B B E	X 1 R 21 19 C B B F
XV-1R/3.2	3,12	250	300	X 1 R 23 19 C B B E	X 1 R 23 19 C B B F
XV-1R/3.8	3,64	250	300	X 1 R 25 19 C B B E	X 1 R 25 19 C B B F
XV-1R/4.3	4,16	250	300	X 1 R 27 19 C B B E	X 1 R 27 19 C B B F
XV-1R/4.9	4,94	250	300	X 1 R 29 19 C B B E	X 1 R 29 19 C B B F
XV-1R/5.9	5,85	250	300	X 1 R 31 19 C B B E	X 1 R 31 19 C B B F
XV-1R/6.5	6,50	250	300	X 1 R 32 19 C B B E	X 1 R 32 19 C B B F
XV-1R/7.8	7,54	220	260	X 1 R 34 19 C B B E	X 1 R 34 19 C B B F
XV-1R/9.8	9,88	190	230	X 1 R 36 19 C B B E	X 1 R 36 19 C B B F

P1) Max. working pressure - P3) Max. peak pressure

For heavy-duty applications, it is recommended to check the admissible torque of the shaft

Dimensions table

TYPE	Weight kg	A	B	C	D	D
		mm	mm	mm	IN	OUT
XV-1R/0.9	0,950	77,1	36,3	65,1	3/8" BSPP	3/8" BSPP
XV-1R/1.2	0,970	78,0	36,8	66,0	3/8" BSPP	3/8" BSPP
XV-1R/1.7	1,010	79,5	37,5	67,5	3/8" BSPP	3/8" BSPP
XV-1R/2.2	1,030	81,5	38,5	69,5	3/8" BSPP	3/8" BSPP
XV-1R/2.6	1,060	83,5	39,5	71,5	3/8" BSPP	3/8" BSPP
XV-1R/3.2	1,090	85,5	40,5	73,5	3/8" BSPP	3/8" BSPP
XV-1R/3.8	1,120	87,5	41,5	75,5	3/8" BSPP	3/8" BSPP
XV-1R/4.3	1,170	89,5	42,5	77,5	3/8" BSPP	3/8" BSPP
XV-1R/4.9	1,200	92,5	44,0	80,5	3/8" BSPP	3/8" BSPP
XV-1R/5.9	1,260	96,0	45,8	84,0	3/8" BSPP	3/8" BSPP
XV-1R/6.5	1,300	97,5	47,0	85,5	3/8" BSPP	3/8" BSPP
XV-1R/7.8	1,360	102,5	49,0	90,5	3/8" BSPP	3/8" BSPP
XV-1R/9.8	1,500	111,5	53,5	99,5	3/8" BSPP	3/8" BSPP

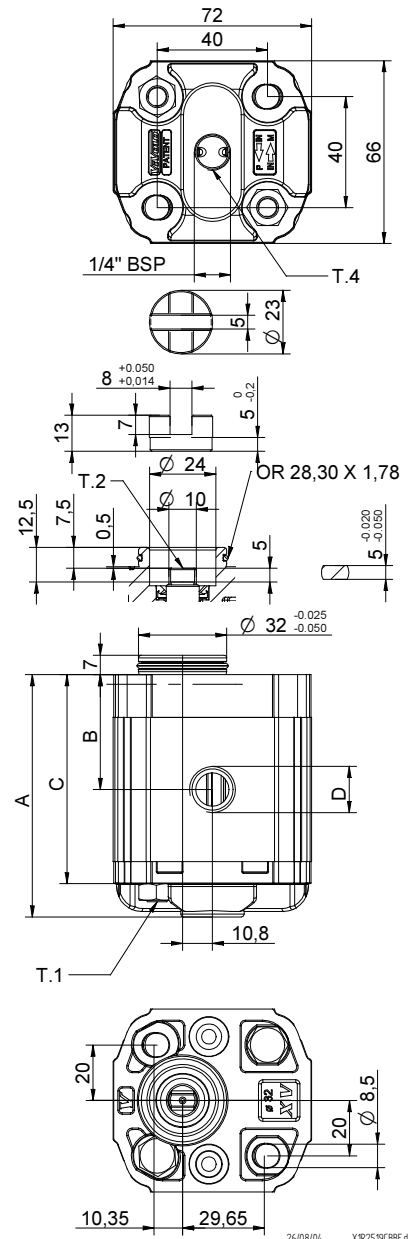

T.1 = 24.5÷29.4 [Nm] - screw tightening torque M8

T.2 = 13.8 [Nm] - admissible shaft torque (N.B. When choosing a shaft, always check the admissible torque).

T.4 = 0.3÷0.5 bar - max. drainage pressure

# Table of variations

**XV-1R**

## Standard German ø32 "BH" FLANGE

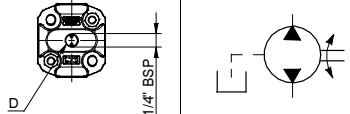
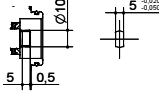
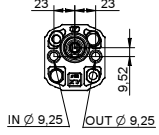
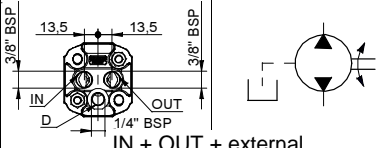
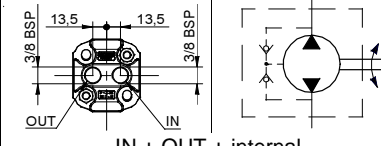
Standard German ø32 "BH" FLANGE		Shaft		Cover		
	19	CF001 - Milled shank T.2 = 13.8 [Nm]	C	SCF01 - Splined T.2 = 42.8 [Nm]	 External drainage	E
			SCF03 - Splined T.2 = 42.8 [Nm]	R		
	22			 IN + OUT + external	K	
				 IN + OUT + internal	L	

Displacement	
TYPE	CODE
XV-1R/0.9	16
XV-1R/1.2	17
XV-1R/1.7	18
XV-1R/2.2	20
XV-1R/2.6	21
XV-1R/3.2	23
XV-1R/3.8	25
XV-1R/4.3	27
XV-1R/4.9	29
XV-1R/5.9	31
XV-1R/6.5	32
XV-1R/7.8	34
XV-1R/9.8	36

Standard bodies				
Displacement cm3/rev	Standard threads			
	0.9	I - I	B - B	J - J
1.2	I - I	B - B	J - J	Z - Z
1.7	I - I	B - B	J - J	Z - Z
2.2	I - I	B - B	J - J	Z - Z
2.6	I - I	B - B	J - J	Z - Z
3.2	I - I	B - B	J - J	Z - Z
3.8	I - I	B - B	J - J	Z - Z
4.3	I - I	B - B	J - J	Z - Z
4.9	I - I	B - B	J - J	Z - Z
5.9	I - I	B - B	J - J	Z - Z
6.5	I - I	B - B	J - J	Z - Z
7.8	I - I	B - B	J - J	Z - Z
9.8	I - I	B - B	J - J	Z - Z

Table showing standard flange and thread combinations available in stock

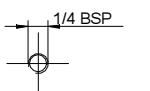
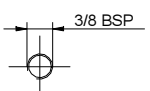
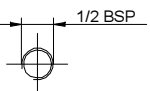
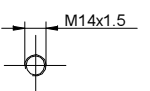
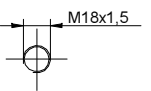
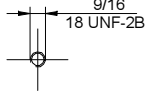
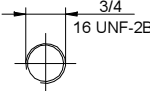
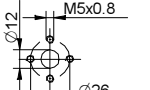
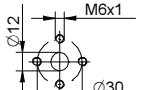
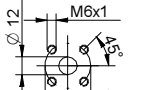
Body (threads/flanges)													
	A		B		C		D		E		F		G
	H		I		J	Closed Body		Z					