

final pump - series XV

X2F-2

SHAPED FINAL PUMP
SHAPED FEMALE $\varnothing 36,5$ FLANGE

X 2 F 51 72 Q P O A

Series	X	series XV
Group	2	group 2
Category	F	final pump
Displacement	51	17
Flange	72	$\varnothing 36.5$ body-shaped female right rotation 2P+2P
Shaft	Q	SCF01 - Final
Body	IN	inlet - $\varnothing 40 \varnothing 20$ M8
	OUT	outlet - $\varnothing 30 \varnothing 13.5$ M6
Cover	A	standard

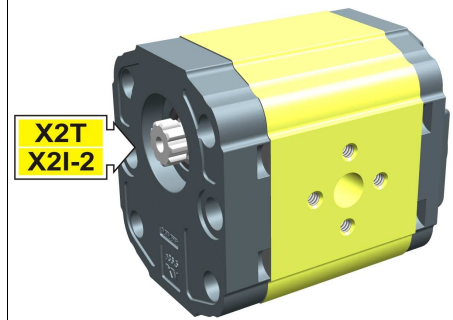

XF202

Technical data table

TYPE	Displacement cm3/rev	Max. Pressure		CODE	
		P1 bar	P3 bar	Left rotation	Right rotation
X2F-2/04	4,20	260	300	X 2 F 41 71 Q O O A	X 2 F 41 72 Q O O A
X2F-2/06	6,00	260	300	X 2 F 43 71 Q O O A	X 2 F 43 72 Q O O A
X2F-2/09	8,40	260	300	X 2 F 45 71 Q O O A	X 2 F 45 72 Q O O A
X2F-2/11	10,80	260	300	X 2 F 47 71 Q O O A	X 2 F 47 72 Q O O A
X2F-2/14	14,40	250	290	X 2 F 49 71 Q P O A	X 2 F 49 72 Q P O A
X2F-2/17	16,80	230	270	X 2 F 51 71 Q P O A	X 2 F 51 72 Q P O A
X2F-2/19	19,20	210	250	X 2 F 53 71 Q P O A	X 2 F 53 72 Q P O A
X2F-2/22	22,80	200	240	X 2 F 55 71 Q P O A	X 2 F 55 72 Q P O A
X2F-2/26	26,20	170	210	X 2 F 57 71 Q Q P A	X 2 F 57 72 Q Q P A
X2F-2/30	30,00	160	200	X 2 F 59 71 Q Q P A	X 2 F 59 72 Q Q P A
X2F-2/34	34,20	150	190	X 2 F 61 71 Q Q P A	X 2 F 61 72 Q Q P A
X2F-2/40	39,60	140	180	X 2 F 63 71 Q Q P A	X 2 F 63 72 Q Q P A

P1) Max. working pressure - P3) Max. peak pressure

For heavy-duty applications, it is recommended to check the admissible torque of the shaft

Dimensions table

TYPE	Weight kg	A	B	D	E	F	D	E	F
		mm	mm	IN			OUT		
X2F-2/04	2,200	87,2	41,7	$\varnothing 13,5$	30	M6x1	$\varnothing 13,5$	30	M6x1
X2F-2/06	2,300	90,2	43,2	$\varnothing 13,5$	30	M6x1	$\varnothing 13,5$	30	M6x1
X2F-2/09	2,400	94,2	45,2	$\varnothing 13,5$	30	M6x1	$\varnothing 13,5$	30	M6x1
X2F-2/11	2,500	98,2	47,2	$\varnothing 13,5$	30	M6x1	$\varnothing 13,5$	30	M6x1
X2F-2/14	2,700	104,2	50,2	$\varnothing 20$	40	M8X1,25	$\varnothing 13,5$	30	M6x1
X2F-2/17	2,800	108,2	52,2	$\varnothing 20$	40	M8X1,25	$\varnothing 13,5$	30	M6x1
X2F-2/19	2,900	112,2	54,2	$\varnothing 20$	40	M8X1,25	$\varnothing 13,5$	30	M6x1
X2F-2/22	3,050	118,2	57,2	$\varnothing 20$	40	M8X1,25	$\varnothing 13,5$	30	M6x1
X2F-2/26	3,150	122,2	59,2	$\varnothing 23,5$	40	M8X1,25	$\varnothing 20$	40	M8X1,25
X2F-2/30	3,400	130,2	63,2	$\varnothing 23,5$	40	M8X1,25	$\varnothing 20$	40	M8X1,25
X2F-2/34	3,600	137,2	66,7	$\varnothing 23,5$	40	M8X1,25	$\varnothing 20$	40	M8X1,25
X2F-2/40	3,800	146,2	71,2	$\varnothing 23,5$	40	M8X1,25	$\varnothing 20$	40	M8X1,25

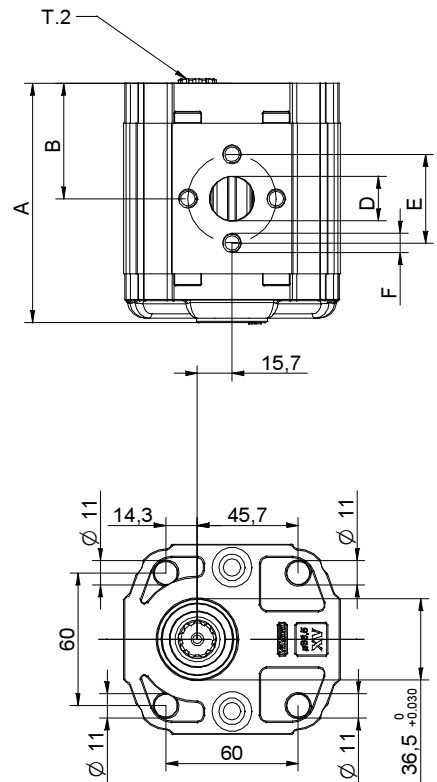
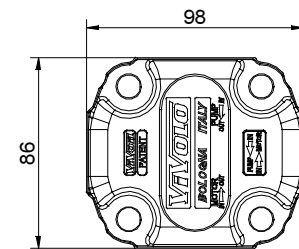



29/04/08 X2F5172P0A.dft

T.2 = 86.2 [Nm] - admissible shaft torque (N.B. When choosing a shaft, always check the admissible torque).

Table of variations

X2F-2

Shaped female $\varnothing 36.5$ FLANGE

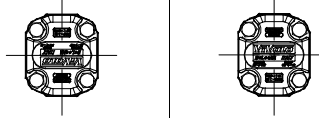
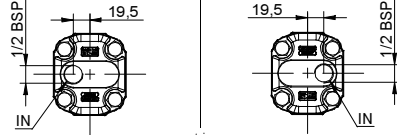
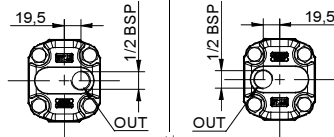
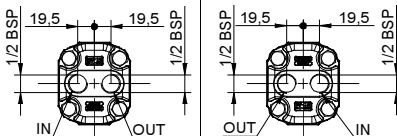
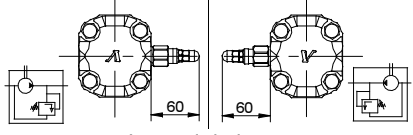
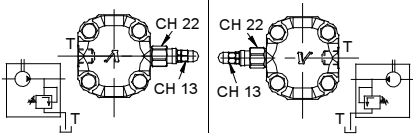
Shaped female $\varnothing 36.5$ FLANGE		Shaft		Cover			
Left rotation	Right rotation			Left rotation	Right rotation		
		71	72	SCF01 - Splined T.2 = 86.2 [Nm] m=1.6 Z=9 DIN 5482 - 17x14 	Q		A
						B	
						C	
						D	
						N	
						O	

Displacement		Standard bodies						
TYPE	CODE	Displacement cm3/rev	Standard threads					
X2F-2/04	41	4	O - O	S - R	B - B	L - M	Z - Z	
X2F-2/06	43	6	O - O	S - R	B - B	L - M	Z - Z	
X2F-2/09	45	9	O - O	S - R	B - B	L - M	Z - Z	
X2F-2/11	47	11	O - O	S - R	B - B	L - M	Z - Z	
X2F-2/14	49	14	P - O	S - R	C - B	L - M	Z - Z	
X2F-2/17	51	17	P - O	S - R	C - B	L - M	Z - Z	
X2F-2/19	53	19	P - O	S - R	C - B	L - M	Z - Z	
X2F-2/22	55	22	P - O	S - R	C - B	L - M	Z - Z	
X2F-2/26	57	26	Q - P	S - R	D - C	L - M	Z - Z	
X2F-2/30	59	30	Q - P	S - S	D - C	L - M	Z - Z	
X2F-2/34	61	34	Q - P	S - S	D - C	L - M	Z - Z	
X2F-2/40	63	40	Q - P	S - S	D - C	L - M	Z - Z	

Table showing standard flange and thread combinations available in stock

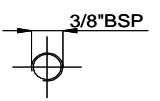
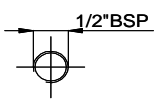
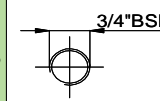
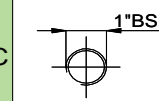
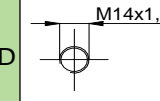
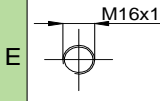
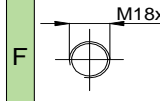
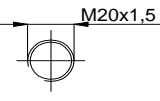
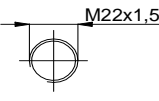
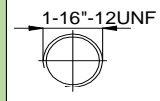
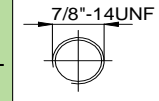
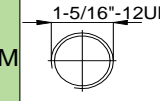
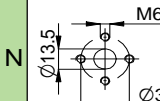
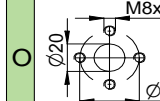
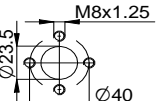
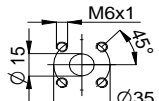
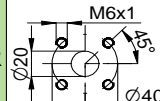
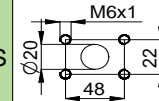
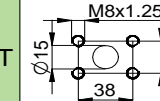
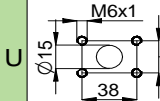
Body (threads/flanges)													
	A		B		C		D		E		F		G
	H		I		L		M		N		O		P
	Q		R		S		T		U		V	Closed Body	Z