

final pump - series XV

X2F-2

STANDARD FINAL PUMP
FEMALE Ø36,5 FLANGE

X 2 F 51 02 Q P O A

Series	X	series XV
Group	2	group 2
Category	F	final pump
Displacement	51	17
Flange	02	Ø36.5 female right rotation 2P+2P, 3P+2P
Shaft	Q	SCF01 - Final
Body	IN	inlet - Ø40 Ø20 M8
	OUT	outlet - Ø30 Ø13.5 M6
Cover	A	standard

X2T
X2I-2
X3T
X3I-3

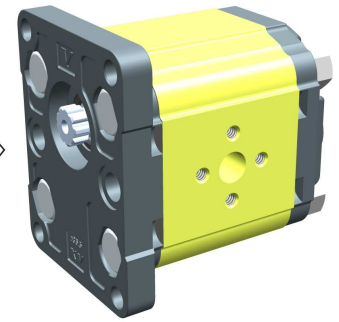

XF201

Technical data table

TYPE	Displacement cm3/rev	Max. Pressure		CODE																	
		P1 bar	P3 bar	Left rotation			Right rotation														
X2F-2/04	4,20	260	300	X	2	F	41	01	Q	O	O	A	X	2	F	41	02	Q	O	O	A
X2F-2/06	6,00	260	300	X	2	F	43	01	Q	O	O	A	X	2	F	43	02	Q	O	O	A
X2F-2/09	8,40	260	300	X	2	F	45	01	Q	O	O	A	X	2	F	45	02	Q	O	O	A
X2F-2/11	10,80	260	300	X	2	F	47	01	Q	O	O	A	X	2	F	47	02	Q	O	O	A
X2F-2/14	14,40	250	290	X	2	F	49	01	Q	P	O	A	X	2	F	49	02	Q	P	O	A
X2F-2/17	16,80	230	270	X	2	F	51	01	Q	P	O	A	X	2	F	51	02	Q	P	O	A
X2F-2/19	19,20	210	250	X	2	F	53	01	Q	P	O	A	X	2	F	53	02	Q	P	O	A
X2F-2/22	22,80	200	240	X	2	F	55	01	Q	P	O	A	X	2	F	55	02	Q	P	O	A
X2F-2/26	26,20	170	210	X	2	F	57	01	Q	Q	P	A	X	2	F	57	02	Q	Q	P	A
X2F-2/30	30,00	160	200	X	2	F	59	01	Q	Q	P	A	X	2	F	59	02	Q	Q	P	A
X2F-2/34	34,20	150	190	X	2	F	61	01	Q	Q	P	A	X	2	F	61	02	Q	Q	P	A
X2F-2/40	39,60	140	180	X	2	F	63	01	Q	Q	P	A	X	2	F	63	02	Q	Q	P	A

P1) Max. working pressure - P3) Max. peak pressure

For heavy-duty applications, it is recommended to check the admissible torque of the shaft

Dimensions table

TYPE	Weight kg	A	B	D	E	F	D	E	F
		mm	mm	IN			OUT		
X2F-2/04	2,200	87,2	41,7	Ø13,5	30	M6x1	Ø13,5	30	M6x1
X2F-2/06	2,300	90,2	43,2	Ø13,5	30	M6x1	Ø13,5	30	M6x1
X2F-2/09	2,400	94,2	45,2	Ø13,5	30	M6x1	Ø13,5	30	M6x1
X2F-2/11	2,500	98,2	47,2	Ø13,5	30	M6x1	Ø13,5	30	M6x1
X2F-2/14	2,700	104,2	50,2	Ø20	40	M8X1,25	Ø13,5	30	M6x1
X2F-2/17	2,800	108,2	52,2	Ø20	40	M8X1,25	Ø13,5	30	M6x1
X2F-2/19	2,900	112,2	54,2	Ø20	40	M8X1,25	Ø13,5	30	M6x1
X2F-2/22	3,050	118,2	57,2	Ø20	40	M8X1,25	Ø13,5	30	M6x1
X2F-2/26	3,150	122,2	59,2	Ø23,5	40	M8X1,25	Ø20	40	M8X1,25
X2F-2/30	3,400	130,2	63,2	Ø23,5	40	M8X1,25	Ø20	40	M8X1,25
X2F-2/34	3,600	137,2	66,7	Ø23,5	40	M8X1,25	Ø20	40	M8X1,25
X2F-2/40	3,800	146,2	71,2	Ø23,5	40	M8X1,25	Ø20	40	M8X1,25

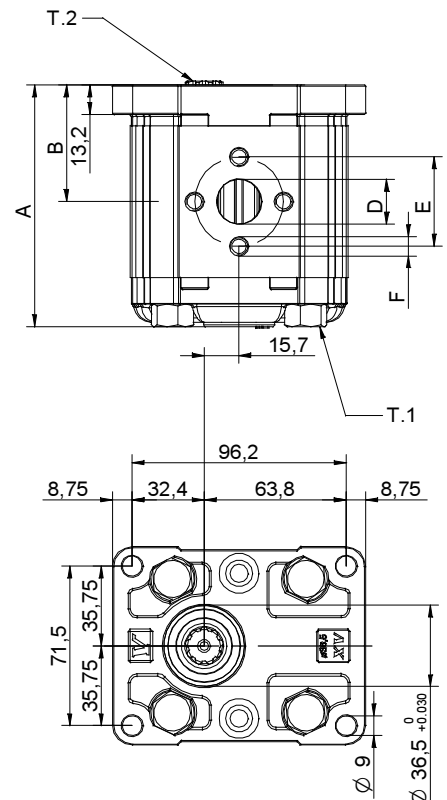
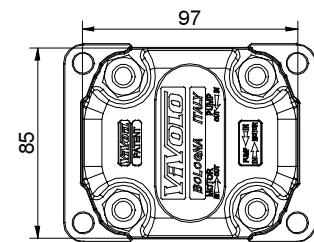

08/04/08 X2F5102P0A.dft



T.1 = 54÷58.9 [Nm] - screw tightening torque M10

T.2 = 86.2 [Nm] - admissible shaft torque (N.B. When choosing a shaft, always check the admissible torque).

Table of variations

X2F-2

Standard female $\varnothing 36.5$ FLANGE

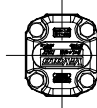
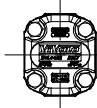
Standard female $\varnothing 36.5$ FLANGE		Shaft		Cover	
Left rotation	Right rotation			Left rotation	Right rotation
		SCF01 - Splined $T.2 = 86.2$ [Nm] $m=1.6$ $Z=9$ DIN 5482 - 17x14 			
	01		02		

Displacement	
TYPE	CODE
X2F-2/04	41
X2F-2/06	43
X2F-2/09	45
X2F-2/11	47
X2F-2/14	49
X2F-2/17	51
X2F-2/19	53
X2F-2/22	55
X2F-2/26	57
X2F-2/30	59
X2F-2/34	61
X2F-2/40	63

Standard bodies						
Displacement cm3/rev	Standard threads					
	4	O - O	S - R	B - B	L - M	Z - Z
6	O - O	S - R	B - B	L - M	Z - Z	Z - Z
9	O - O	S - R	B - B	L - M	Z - Z	Z - Z
11	O - O	S - R	B - B	L - M	Z - Z	Z - Z
14	P - O	S - R	C - B	L - M	Z - Z	Z - Z
17	P - O	S - R	C - B	L - M	Z - Z	Z - Z
19	P - O	S - R	C - B	L - M	Z - Z	Z - Z
22	P - O	S - R	C - B	L - M	Z - Z	Z - Z
26	Q - P	S - R	D - C	L - M	Z - Z	Z - Z
30	Q - P	S - S	D - C	L - M	Z - Z	Z - Z
34	Q - P	S - S	D - C	L - M	Z - Z	Z - Z
40	Q - P	S - S	D - C	L - M	Z - Z	Z - Z

Table showing standard flange and thread combinations available in stock

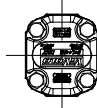
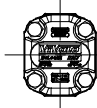
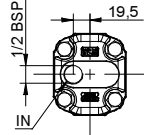
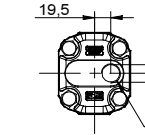
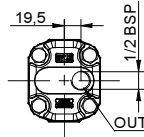
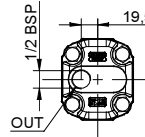
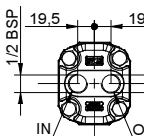
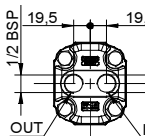
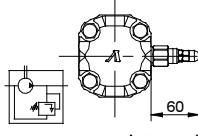
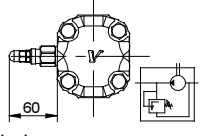
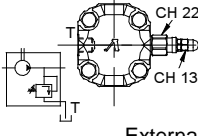
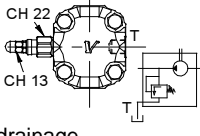
Cover		
Left rotation	Right rotation	
		A
		B
		C
		D
		N
Internal drainage		
		O
External drainage		

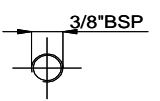
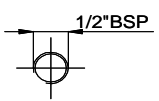
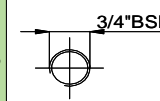
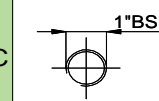
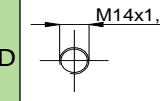
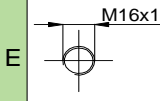
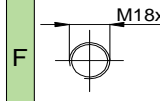
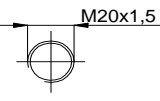
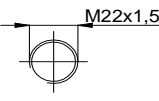
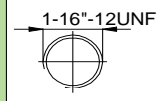
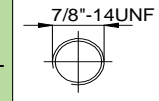
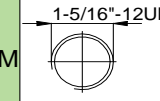
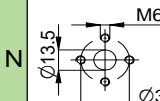
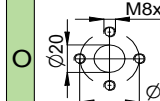
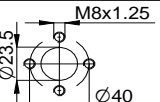
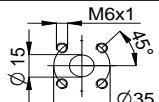
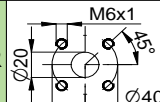
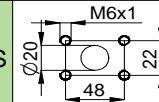
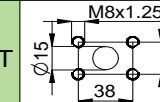
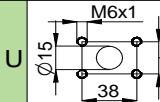
Body (threads/flanges)													
	A		B		C		D		E		F		G
	H		I		L		M		N		O		P
	Q		R		S		T		U		V	Closed Body	Z