



## MATERIALS

BASE BODY	11 S MN P8 30 - UNI EN 10087
CARTRIDGE BODY	35 S MN P8 10 - UNI EN 10087
COMPENSATING UNIT	38 Ni CR MO 4 UNI - EN 10083
OR	NITRILE
ANTIEXTRUSION RING	PTFE
KNOB	GD - AL SI 12 - UNI EN AB 46100

## EXAMPLE FOR ORDERING

ACCESSOIRES ON REQUEST			
CODE	TYPE	PANEL RING NUT	VITON SEAL
FT 277/5	12	G	V

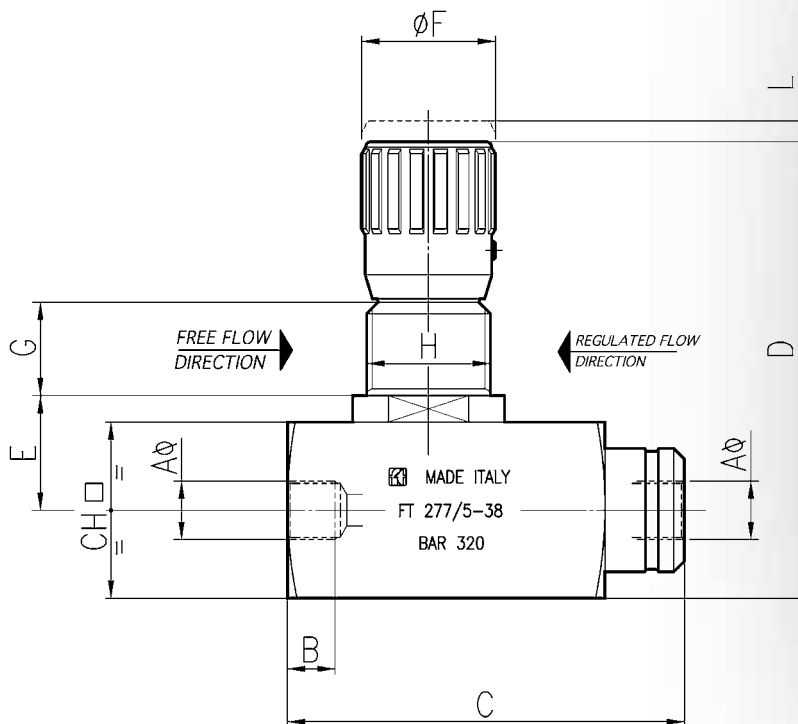

## DIMENSIONS

TYPE	A UNI338	B	C	D	E	ØF	G	H	L	CH	WEIGHT KG
14	1/4" G	12,5	93,5	107	28	33	17	M30x1,5	4,5	45	1,400
38	3/8" G	12,5	112,5	129,5	32	38	27	M35x1,5	6	50	2,000
12	1/2" G	15,5	136	150	38	47	28,5	M40x1,5	6,5	60	3,500
34	3/4" G	17	163	182,5	45	58	35	M50x1,5	7,5	70	7,000

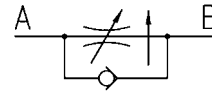

## SINGLE-ACTING PRESSURE COMPENSATED FLOW CONTROL VALVES

The double-port control valves, pressure compensated and including high capacity single acting valve to allow the free flow in one direction. They include two necks in series:

- the first one with port section definable by an external control;
- the second one with automatically variable section in relation with counter pressure variations on use.

The choice of the adjustable neck situated upstream is that which best ensures the precision of the valve towards variations of the fluid temperature.

Regarding the structure of the valve, the following points must be underlined:

- the rigorous symmetry of the internal components such as to impede unforeseen perturbations of the static and dynamic balances;
- the optimisation of the arrangement of internal spring controlling the intervention of the automatic throttling, with variable preload with throttling fixed setting, useful to improve the behaviour at medium-high flow rates;
- the geometry of the passage across which the flow is automatically throttled, designed to minimize the effect of the flow hydromechanics forces on the total balance of the moving element;
- the accuracy of the machining which enabled to cancel any hysteresis effect of mechanical origin;
- the original aesthetic feature, underlined by the particular form of the control knob;
- the easiness to reset the flow value thanks to reference pointers.

Moreover we believe important to underline the choice of the constructive solution fitting to the concept of "double valence", according to which the central body, configurated as a threaded cartridge and insertable in the two different bodies at the base or directly in standard modular units, brings about the three marketed versions:

- FT 277/2 two-way
- FT 277/ 5 two-way with single-acting valve
- FT 287/2 with cartridge mounted.

This solution enables the user to request the single modular components to be assembled according to the application.

On request

- equipped with ring nuts (G)
- Viton seals (V)



# FT 277/5

### TECHNICAL DATA

TYPE	MAX WORKING PRESSURE BAR	MIN. $\Delta P$ WORKING BAR	WORKING TEMPERATURE C°	FILTRATION GRADE $\mu\text{M}$ ABSOLUTE
14	320	7,5	-20°/+70°	25
38	320	10	-20°/+70°	25
12	320	12	-20°/+70°	25
34	320	15	-20°/+70°	25



FT 277/5

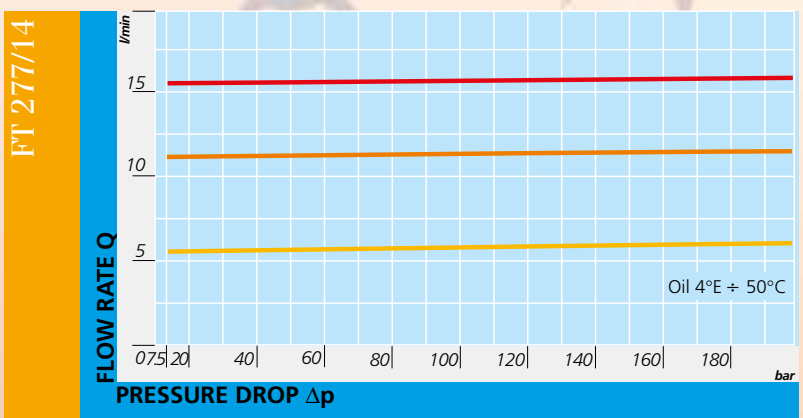
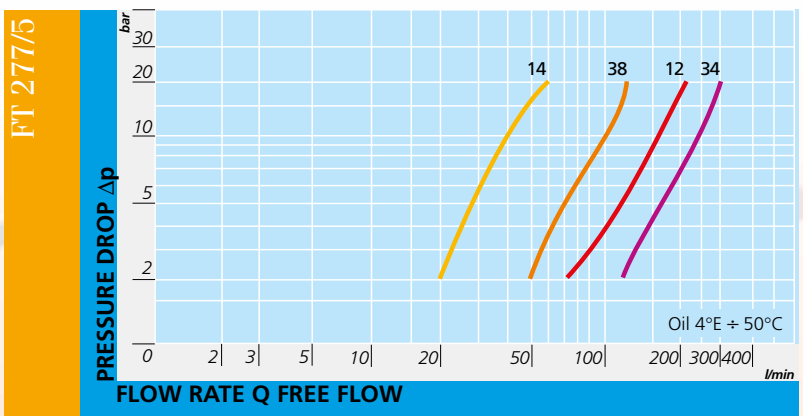
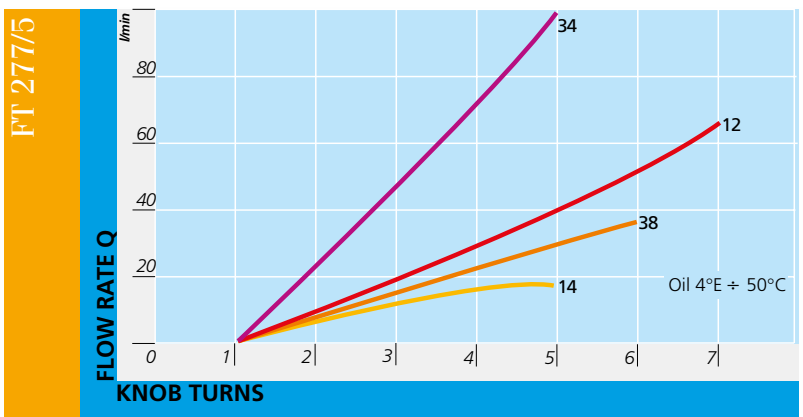

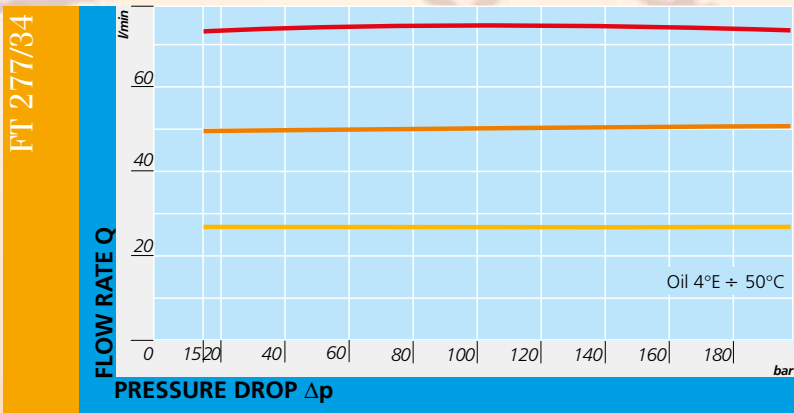
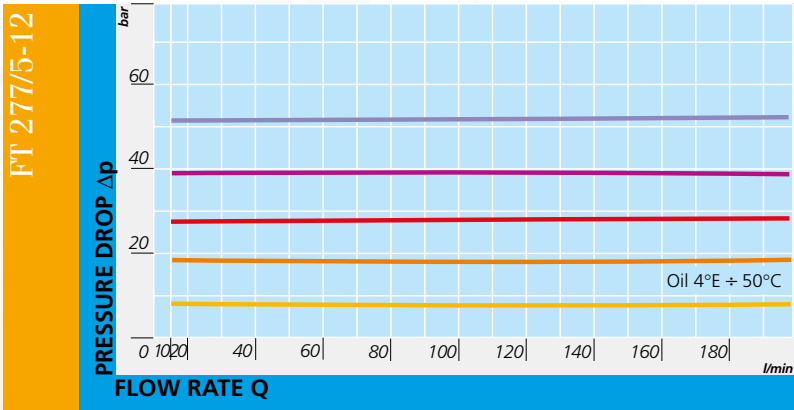
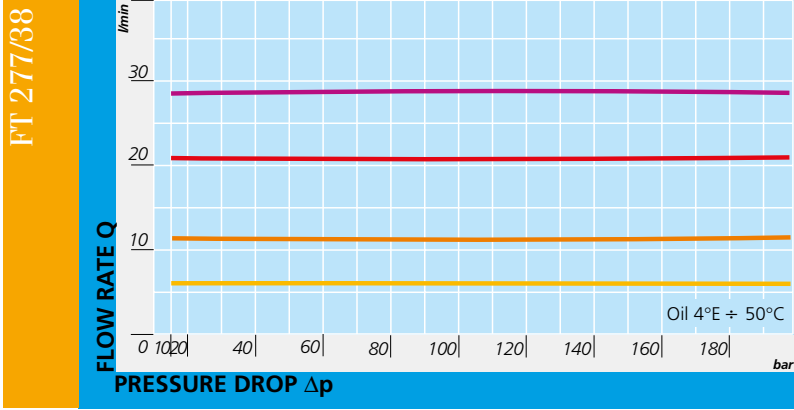

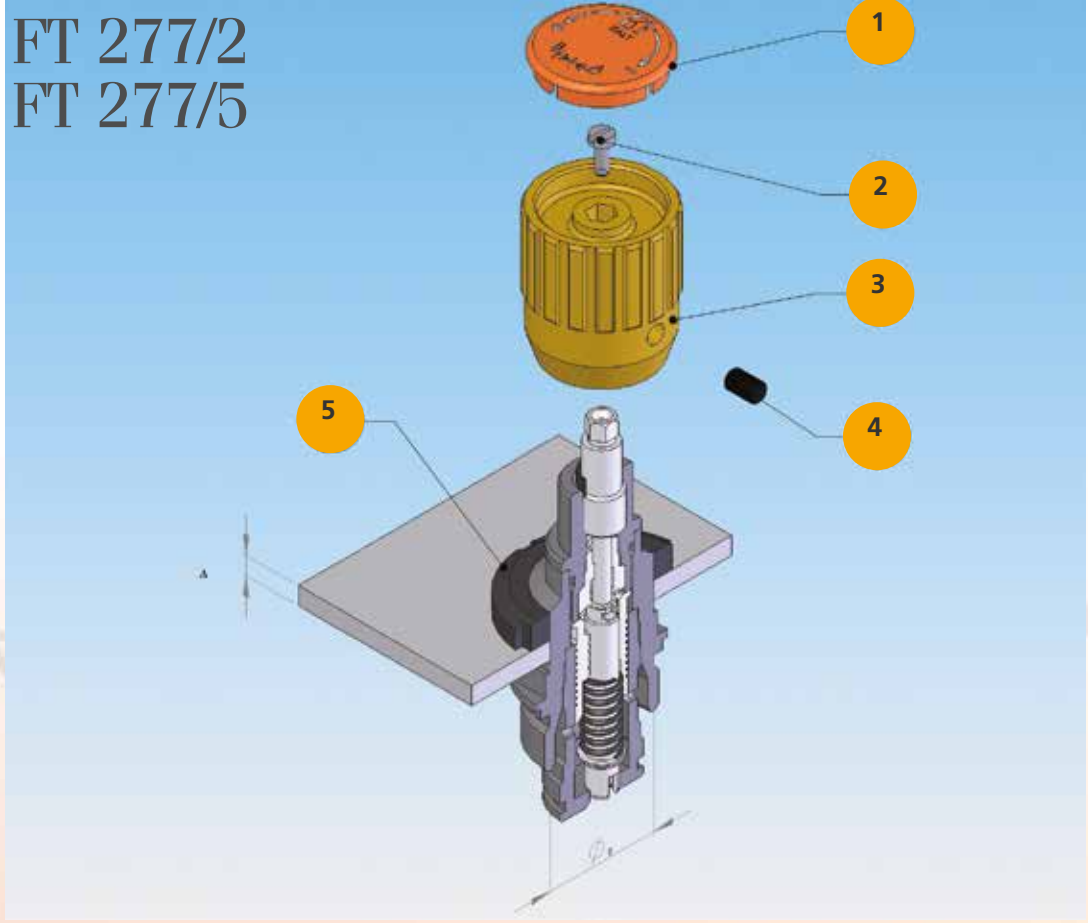

# PANEL MOUNTING INSTRUCTION

## PANEL MOUNTING

1°	UNSCREW LOCK SCREW (4)
2°	REMOVE COVER PLATE (1)
3°	UNSCREW SCREW (2)
4°	PULL OFF HANDLE (3)
5°	INSERT RING NUT (5), ON REQUEST IT IS SUPPLIED WITH THE VALVE

TYPE VALVE	PANEL THICKNESS A MAX	BORE FOR PANEL MOUNTING
18	10	31
38	10	36
12	10	41
34	10	51



FT 277/2 - FT 277/5