

High Response Type Proportional Electro-Hydraulic Directional and Flow Control Valves

High response, high precision and high reliability are achieved by a combination of a compact and powerful solenoid and a spool-position-detection LVDT.

Direct type ELDFG-01/03 and two stage type ELDFG-04/06 (which use the ELDFG-01 as a pilot) are available.

Direct Operated Type Directional and Flow Control Valves

This product can be interchanged with the simplified servo valve to perform position control and pressure control.

Compared to nozzle flapper type servo valve, this product has excellent contamination-related problems.

Specifications

Description		Model No.	ELDFG-01	ELDFG-03
Max. Operating Pressure		MPa (PSI)	31.5 (4570)	
Max. Tank Line Back Pressure		MPa (PSI)	21 (3050)	
Rated Flow	L/min (U.S.GPM)		10: 10 (2.6)	40: 40 (10.6)
	Valve Pres. Diff. : 1.5 MPa (220 PSI)		20: 20 (5.3)	80: 80 (21.1)
			35: 35 (9.2)	
Hysteresis			0.5% or less	
Repeatability			0.5% or less	
Step Response (Typical Rating)	0 → 100%		30 ms	3C2, 3C40: 29 ms 3C2P: 25 ms
	100 → 0%		38 ms	3C2, 3C40: 26 ms 3C2P: 23 ms
Frequency Response (0 ±25 %V)	Phase -90 degree		48 Hz	3C2, 3C40: 36 Hz 3C2P: 41 Hz
	Gain -3 dB		52 Hz	3C2, 3C40: 35 Hz 3C2P: 38 Hz
Rated Current			Max. 2.5 A	Max. 3 A
Coil Resistance [20°C (68°F)]			3.9 Ω	3 Ω
Power Input			Max. 25 W	Max. 27 W
Approx. Mass		kg (lbs.)	3.2 (7.1)	7.5 (16.5)

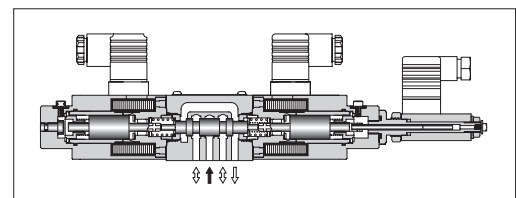
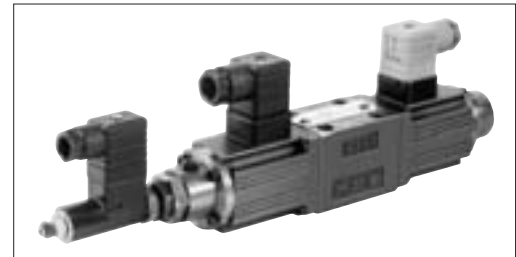

Graphic Symbols

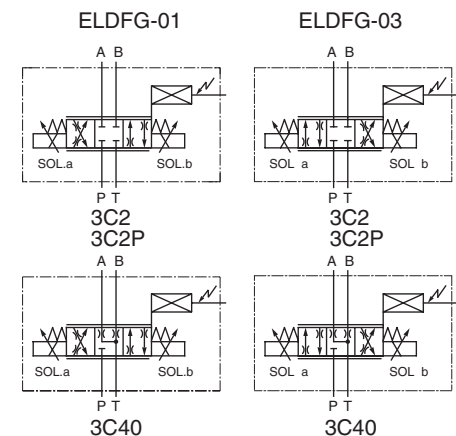

Range of Flow Control

See “Valve Pres. Difference vs. Flow Rate” below characteristics for the appropriate range.

ELDFG-01

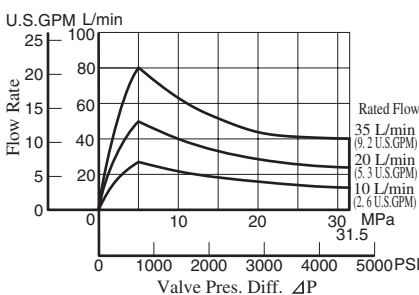
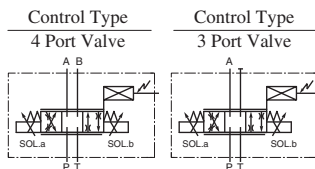

ELDFG-03

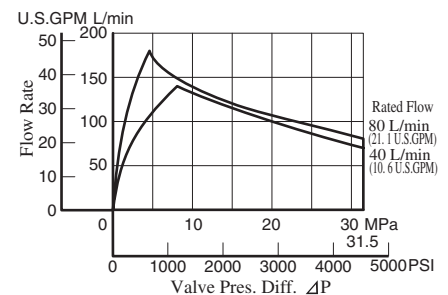
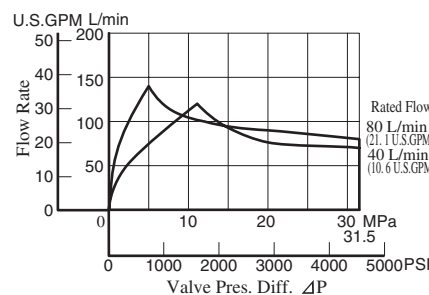

★ Valve pressure difference “ΔP” is reference by follows. In addition, “P”, “A”, “B”, “T”, are pressure of each port.

4 Port Valve: ΔP = [(P-A) + (B-T)] or [(P-B) + (A-T)]

3 Port Valve: ΔP = (P-A) or (A-T)

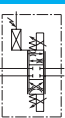

Model Number Designation

F-	ELDF	G	-01	-35	-3C2	-XY	-10	*
Special Seals	Series Number	Type of Mounting	Valve Size	Rated Flow L/min (U.S.GPM)	Spool Type	Direction of Flow	Design Number	Design Standards
F: Special Seals for Phosphate Ester Type Fluid (Omit if not required)	ELDF: High Response (Direct) Type Proportional Electro-Hydraulic Directional and Flow Control Valves	G: Sub-plate Mounting	01	10: 10 (2.6) 20: 20 (5.3) 35: 35 (9.2)		XY: Metre-In · Metre-Out	10	Refer to ★
			03	40: 40 (10.6) 80: 80 (21.1)			10	

★ Design Standards: None Japanese Standard "JIS" and European Design Standard 90 N. American Design Standard

Attachment

Mounting Bolts

Four socket head cap screws in the table below are included.

Model No.	Descriptions	Soc. Hd. Cap Screw (4 pcs.)	Tightening Torque
ELDFG-01	Japanese Standard "JIS" European Design Standard	M5 × 45 Lg.	5 - 7 Nm (43 - 60 in. lbs.) [Applicable to working pressure more than 25 MPa (3630 PSI): 6 - 7 Nm (52 - 60 in. lbs.)]
	N. American Design Standard	No. 10-24 UNC × 1-3/4 Lg.	
ELDFG-03	Japanese Standard "JIS" European Design Standard	M6 × 35 Lg.	12 - 15 Nm (106 - 133 in. lbs.)
	N. American Design Standard	1/4-20 UNC × 1-1/2 Lg.	

Sub-plate

Valve Model Numbers	Piping Size	Japanese Standard "JIS"		European Design Standard		N. American Design Standard		Approx. Mass kg (lbs.)
		Sub-plate Model Numbers	Thread Size	Sub-plate Model Numbers	Thread Size	Sub-plate Model Numbers	Thread Size	
ELDFG-01	1/8	DSGM-01-31	Rc 1/8	DSGM-01-3180	1/8 BSPF	DSGM-01-3190	1/8 NPT	0.8 (1.8)
	1/4	DSGM-01X-31	Rc 1/4	DSGM-01X-3180	1/4 BSPF	DSGM-01X-3190	1/4 NPT	0.8 (1.8)
	3/8	DSGM-01Y-31	Rc 3/8	—	—	DSGM-01Y-3190	3/8 NPT	0.8 (1.8)
ELDFG-03	3/8	DSGM-03-40	Rc 3/8	DSGM-03-2180	3/8 BSPF	DSGM-03-2190	3/8 NPT	3.0 (6.6)
	1/2	DSGM-03X-40	Rc 1/2	DSGM-03X-2180	1/2 BSPF	DSGM-03X-2190	1/2 NPT	3.0 (6.6)
	3/4	DSGM-03Y-40	Rc 3/4	DSGM-03Y-2180	3/4 BSPF	DSGM-03Y-2190	3/4 NPT	4.7 (10.4)

- Sub-plates are available. Specify the sub-plate model number from the table above. When sub-plates are not used, the mounting surface should have a good machined finish.
- The Sub-plates are those for 1/8 and 3/8 solenoid operated directional valves. For dimensions, see page 356 and 373.

Applicable Power Amplifiers

For stable performance, it is recommended that Yuken's applicable power amplifiers be used (for details see page 786).

Valve Model Numbers	Power Amplifier Model Numbers
ELDFG-01-* - ^{3C2} / _{3C40}	AMN-L-01-1-10
ELDFG-01-* -3C2P	AMN-L-01-3-2P-10
ELDFG-03-* - ^{3C2} / _{3C40}	AMB-EL-03-1-10
ELDFG-03-* -3C2P	AMB-EL-03-2P-1-10

ELDFG-01--XY-10/1090**

Mounting surface: Conform to ISO4401-AB-03-4-A.

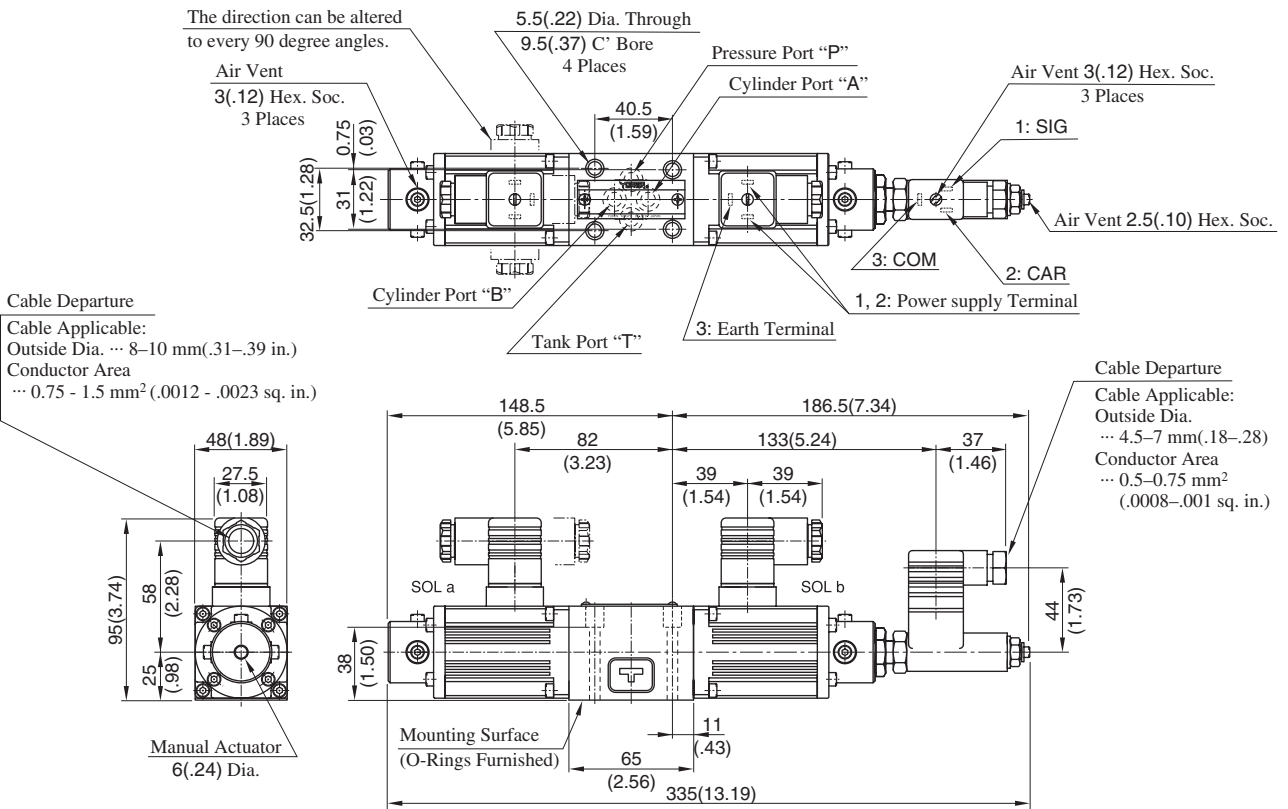

Note: For valve mounting surface dimensions, see the dimensional drawings of sub-plates (p.356) in common use.

ELDFG-03--XY-10/1090**

Mounting surface: Conform to ISO4401-AC-05-4-A.

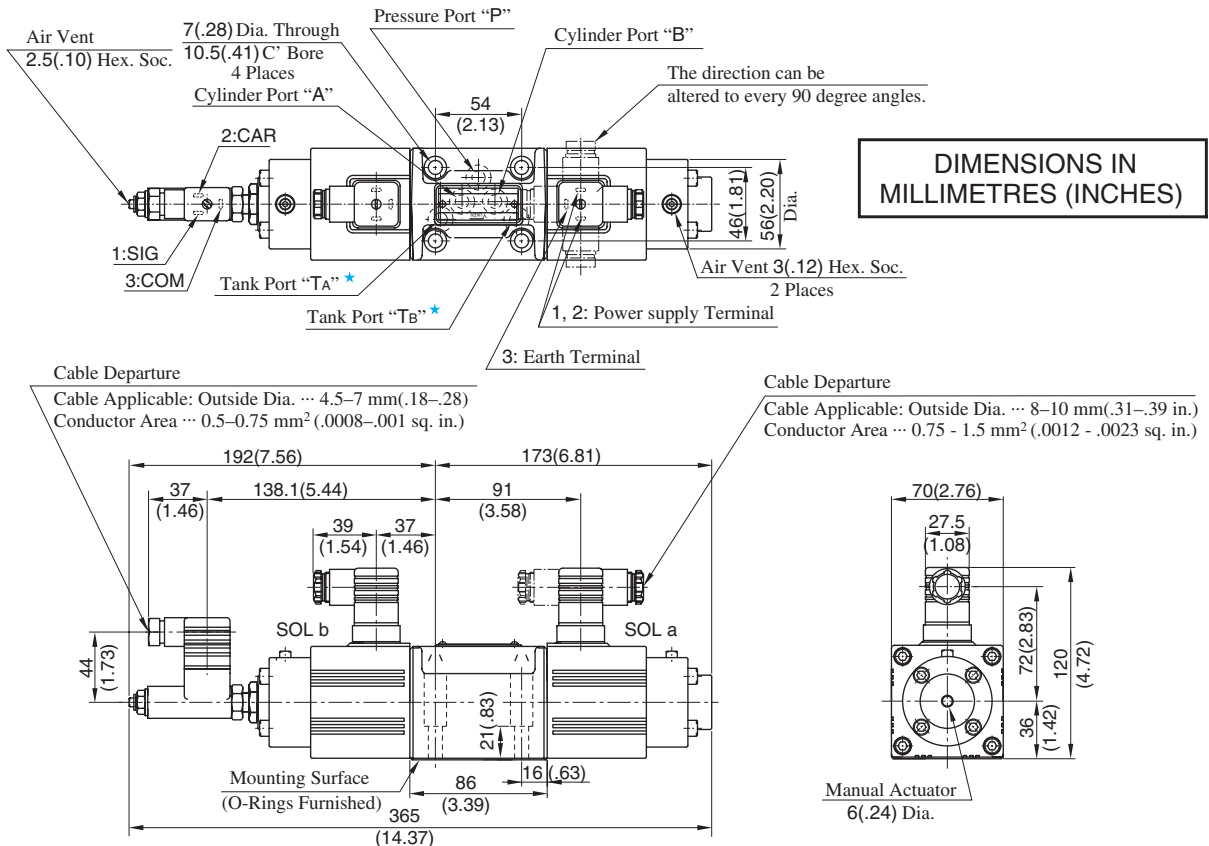

Note: For valve mounting surface dimensions, see the dimensional drawings of sub-plates (p.373) in common use.

H
E Series
Direct Operated Type Directional and Flow Control Valves

Input Voltage vs. Flow Rate

ELDFG-01-* -3C2/3C40

Valve Pres. Diff. : 1.2 MPa (174 PSI)
 Viscosity : 30 mm²/s (141 SSU)

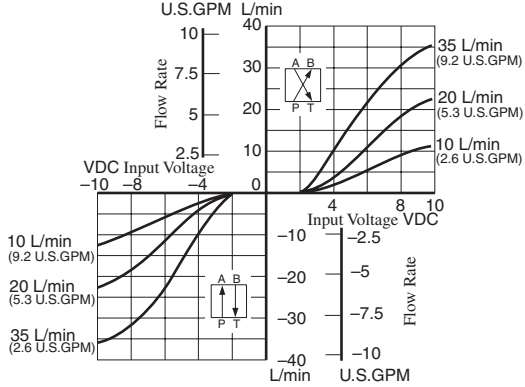

ELDFG-01-* -3C2P

Valve Pres. Diff. : 1.2 MPa (174 PSI)
 Viscosity : 30 mm²/s (141 SSU)

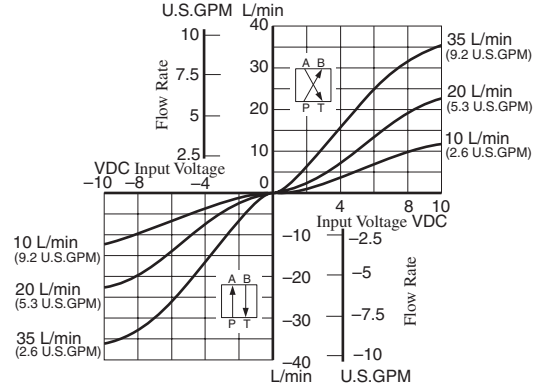

ELDFG-03-* -3C2/3C40

Valve Pres. Diff. : 1.5 MPa (218 PSI)
 Viscosity : 30 mm²/s (141 SSU)

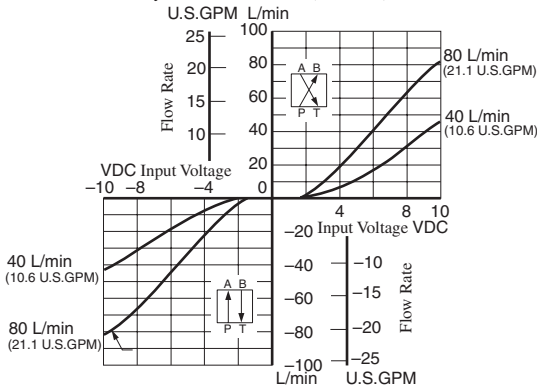

ELDFG-03-* -3C2P

Valve Pres. Diff. : 1.5 MPa (218 PSI)
 Viscosity : 30 mm²/s (141 SSU)

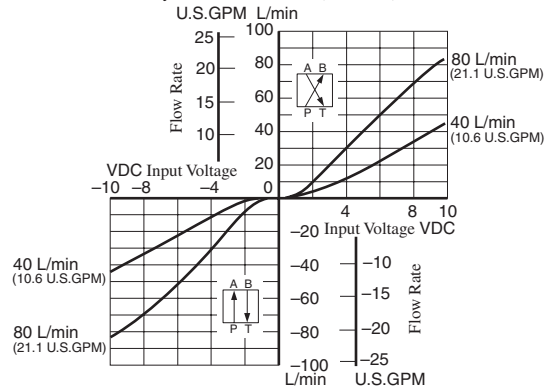

Input Voltage vs. Spool St.

ELDFG-01-* -3C2/3C40

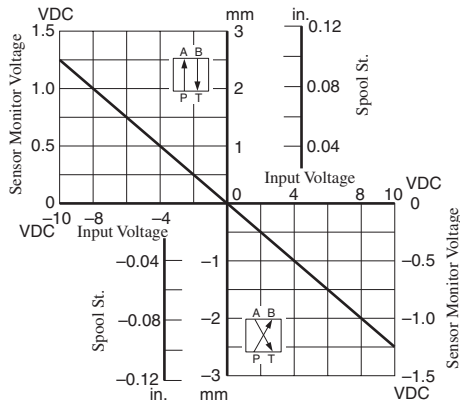

ELDFG-01-* -3C2P

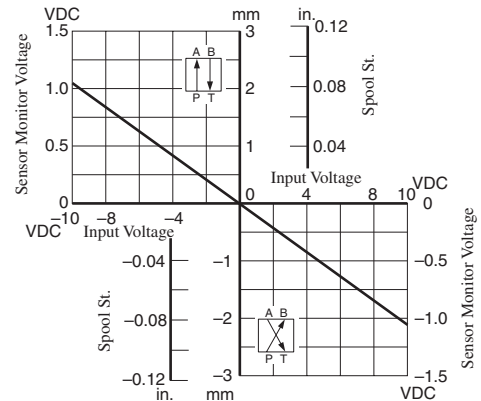

ELDFG-03-* -3C2/3C40

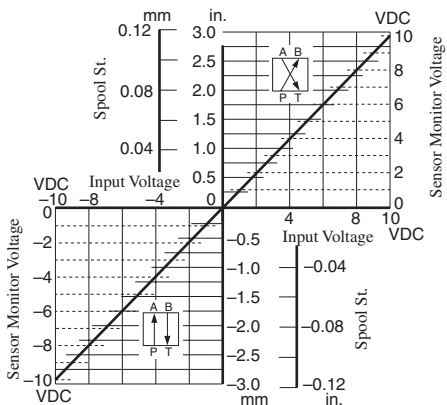

ELDFG-03-* -3C2P

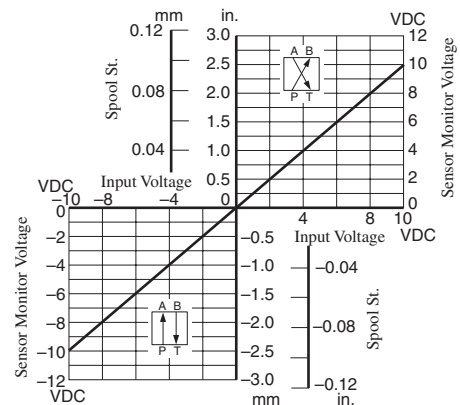

Step Response (Example)

Viscosity : 30 mm²/s (140 SSU)

The values were measured on independent valves. They vary by circuit.

ELDFG-01-35-3C2/3C40

Supply Pressure : 2 MPa (290 PSI)
Flow Rate : 35 L/min (9.2 U.S.GPM)

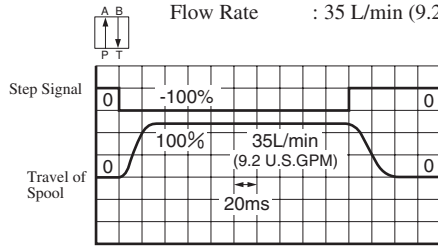

ELDFG-01-35-3C2P

Supply Pressure : 2 MPa (290 PSI)
Flow Rate : 35 L/min (9.2 U.S.GPM)

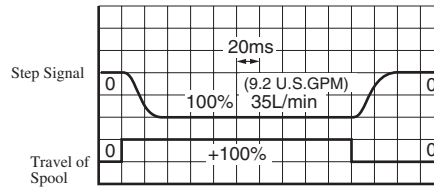
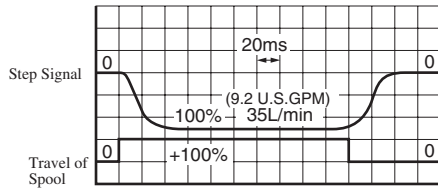
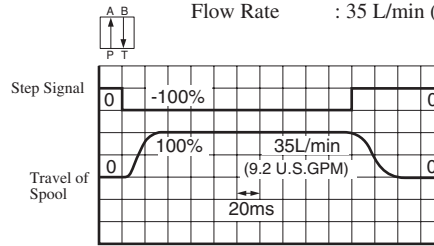

ELDFG-03-80-3C2/3C40

Supply Pressure : 4 MPa (580 PSI)
Flow Rate : 80 L/min (21.1 U.S.GPM)

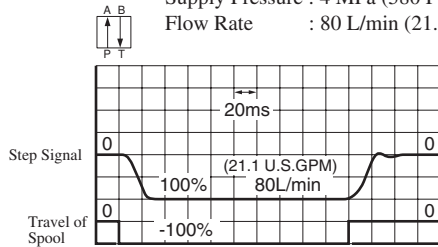

ELDFG-03-80-3C2P

Supply Pressure : 4 MPa (580 PSI)
Flow Rate : 80 L/min (21.1 U.S.GPM)

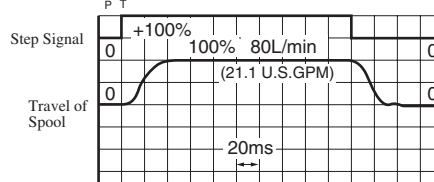
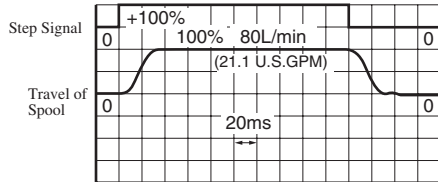
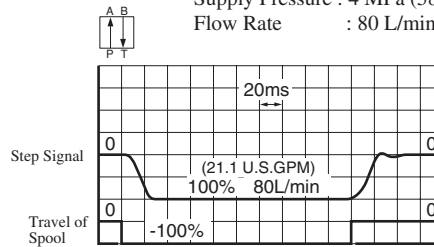

Frequency Response

Input Signal : 0 ±25 %V
Primary Pressure : 14 PMa (2030 PSI)
Viscosity : 30 mm²/s (140 SSU)

ELDFG-01-35-3C2/3C40/3C2P

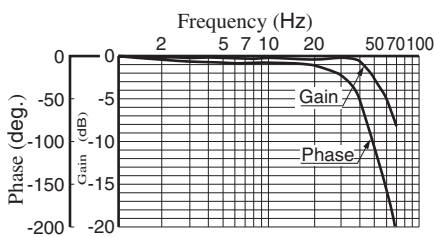

ELDFG-03-80-3C2/3C40

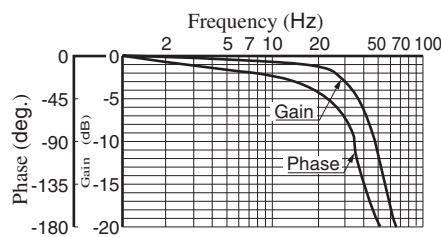

ELDFG-03-80-3C2P

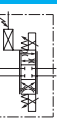
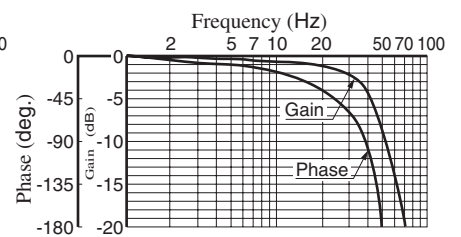

■ List of Seals and Solenoid Ass'y

ELDFG-01-*-*-XY-10/1090

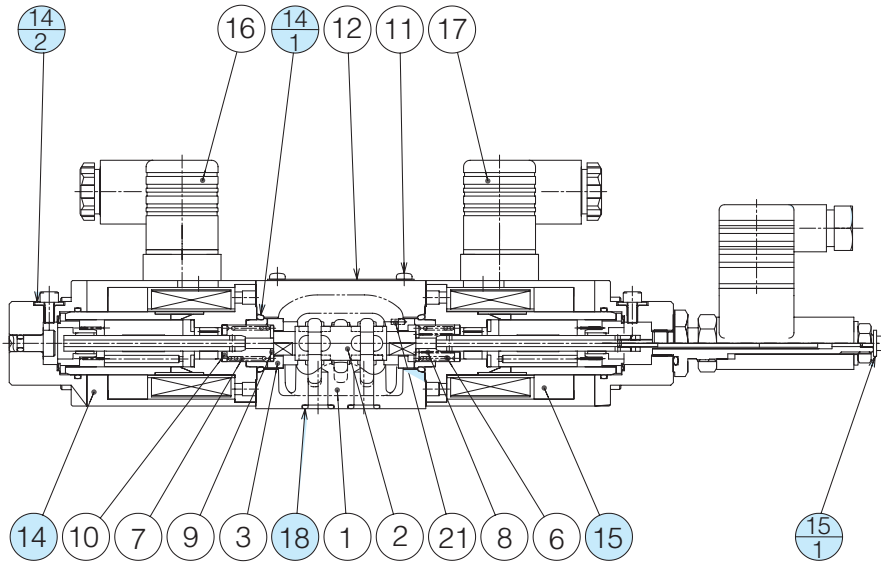

● List of Seals

Item	Name of Parts	Part Numbers	Qty.	Remarks
14-1	O-Ring	SO-NB-P18	2	Included in Seal Kit Kit No.: KS-ELDFG-01-10
14-2	Fastner Seal	SG-FCF-4	2	
15-1	Fastner Seal	TK280152-0	1	
18	O-Ring	SO-NB-P9	4	

Note) O-ring (Item 14-1) and the fastner sael (Item 14-2, 15-1) are included in the solenoid assembly.

● Solenoid Ass'y

Valve Model Numbers	Item	Solenoid Ass'y	Qty.
ELDFG-01-*-*-XY-10/1090	14	E318-Y06M2-14-5007	1
	15	E318-Y06M2-14-L-5007	1

Note) The connector assembly GDM-211-*-11 (Item 16, 17) is not included in the solenoid assembly.

■ List of Seals and Solenoid Ass'y

ELDFG-03-**-**-XY-10/1090

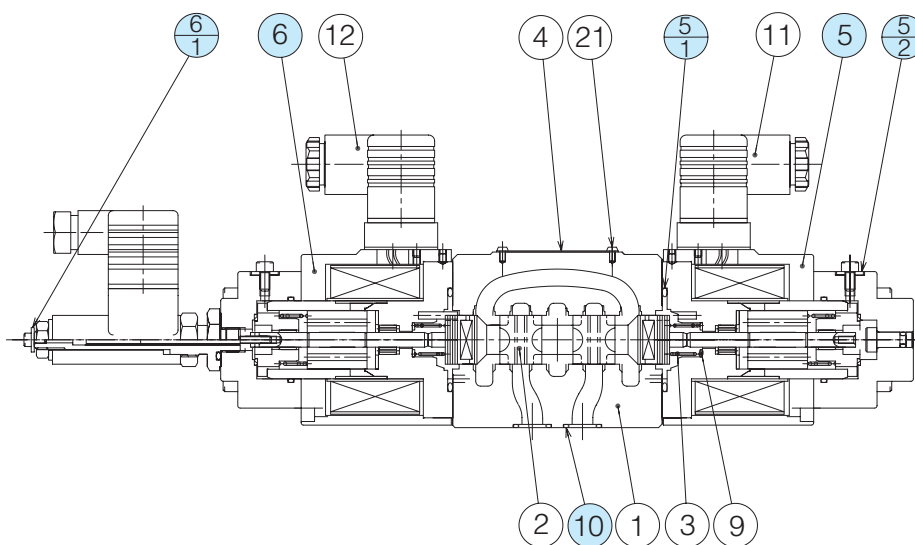

● List of Seals

Item	Name of Parts	Part Numbers	Qty.	Remarks
5-1	O-Ring	SO-NB-A128	2	Included in Seal Kit Kit No.: KS-ELDFG-03-10
5-2	Fastner Seal	SG-FCF-4	2	
6-1	Fastner Seal	TK280152-0	1	
10	O-Ring	SO-NB-A014	4	

Note) O-ring (Item 5-1) and the fastener seal (Item 5-2, 6-1) are included in the solenoid assembly.

● Solenoid Ass'y

Valve Model Numbers	Item	Solenoid Ass'y	Qty.
ELDFG-03-**-**-XY-10/1090	5	E324-Y12M2-28-10	1
	6	E324-Y12M2-28-L-10	1

Note) The connector assembly GDM-211-**-11 (Item 11, 12) is not included in the solenoid assembly.