

PRM7

PILOT OPERATED PRESSURE RELIEF VALVE SERIES 10

MODULAR VERSION
ISO 4401-07 (CETOP 07)

p max **350** bar
Q max **300** l/min

MOUNTING INTERFACE

ISO 4401-07-07-0-05
(CETOP 4.2-4-07)

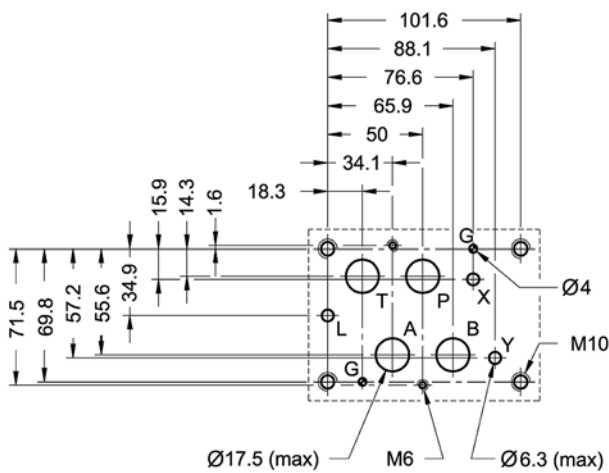

OPERATING PRINCIPLE

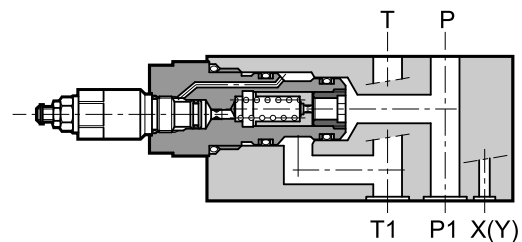

- The PMR7 valve is a pilot operated pressure relief valve made as a modular version with a mounting surface according to ISO 4401 (CETOP RP 121H) standards.
- It can be assembled with all ISO 4401-07 (CETOP 07) modular valves without the use of pipes, using suitable tie-rods or bolts.
- It is available in the type for single adjustment on line P and discharge in T with two pressure adjustment ranges.
- This valve is normally used as a hydraulic circuit pressure limiting device.
- It is normally supplied with an adjustment screw.

PERFORMANCES (measured with mineral oil of viscosity 36cSt at 50°C)

Maximum operating pressure	bar	350
Maximum flow rate	l/min	300
Ambient temperature range	°C	-20 / +50
Fluid temperature range	°C	-20 / +80
Fluid viscosity range	cSt	10 ÷ 400
Fluid contamination degree	According to ISO 4406:1999 class 20/18/15	
Recommended viscosity	cSt	25
Mass:	kg	8,5

HYDRAULIC SYMBOL

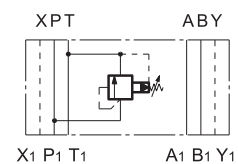



1 - IDENTIFICATION CODE

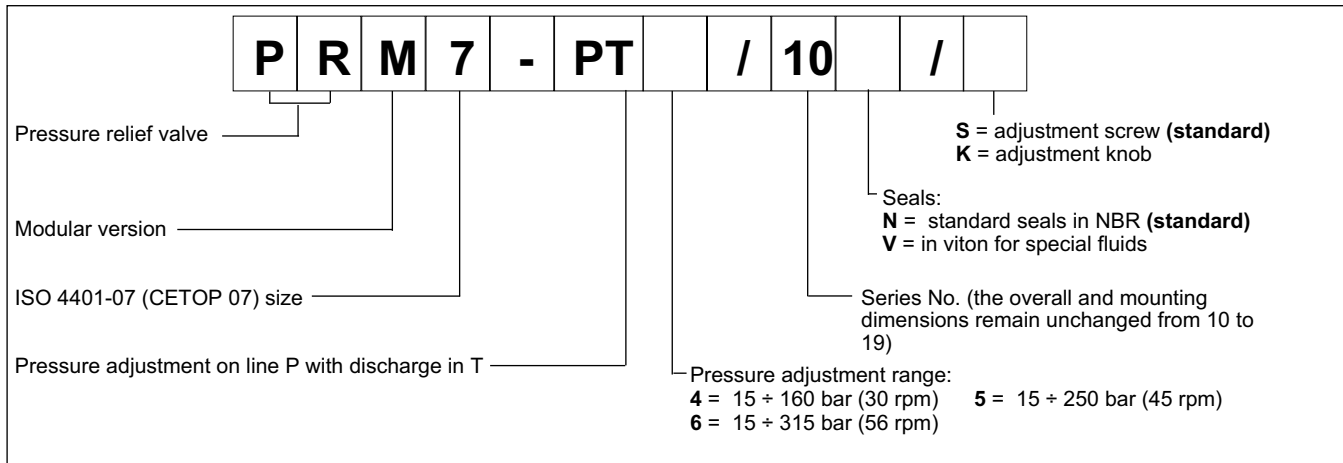

2 - CHARACTERISTIC CURVES (values obtained with viscosity of 36 cSt at 50°C)

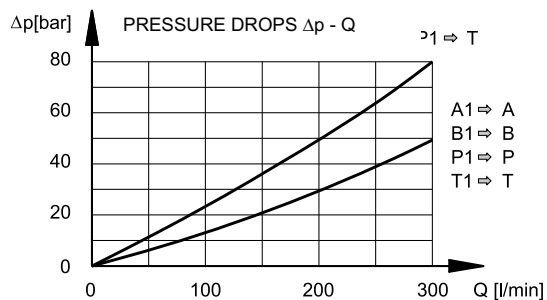
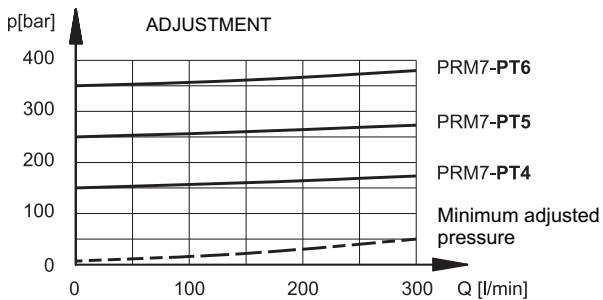

3 - HYDRAULIC FLUIDS

Use mineral oil-based hydraulic fluids HL or HM type, according to ISO 6743-4. For these fluids, use NBR seals. For fluids HFDR type (phosphate esters) use FPM seals (code V). For the use of other kinds of fluid such as HFA, HFB, HFC, please consult our technical department. Using fluids at temperatures higher than 80 °C causes a faster degradation of the fluid and of the seals characteristics. The fluid must be preserved in its physical and chemical characteristics.

4 - OVERALL AND MOUNTING DIMENSIONS

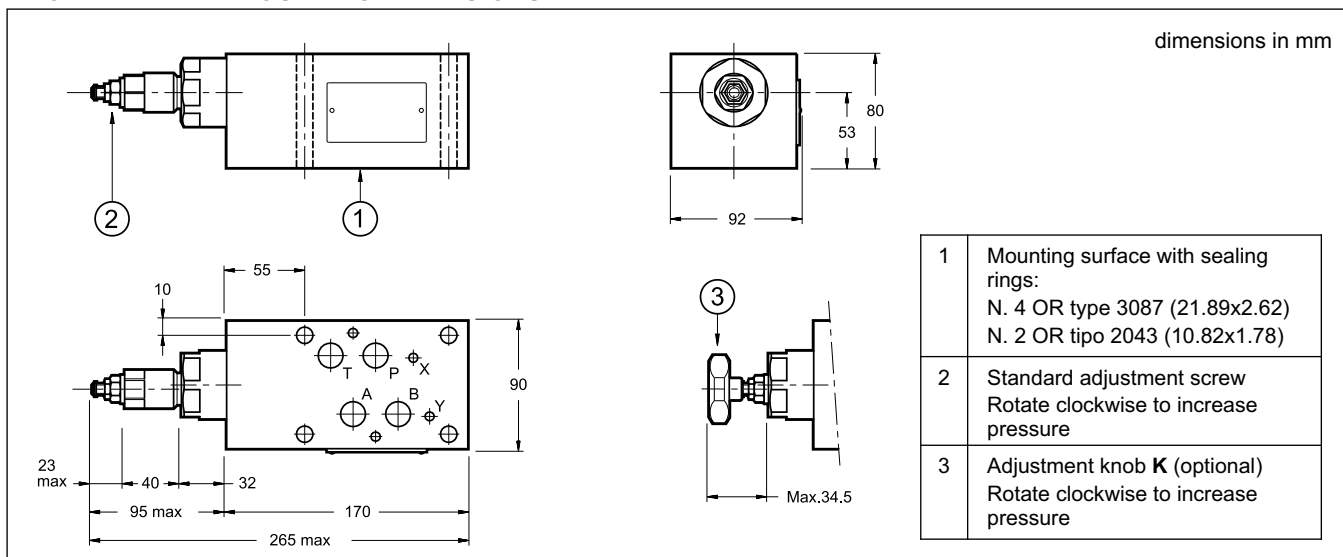

DIPLOMATICO OLEODINAMICA S.p.A.
20015 PARABIAGO (MI) • Via M. Re Depaolini 24
Tel. +39 0331.895.111
Fax +39 0331.895.339
www.diplomatic.com • e-mail: sales.exp@diplomatic.com